

12'X20' Add Kit Shade Structure

SKU: SAK12x20

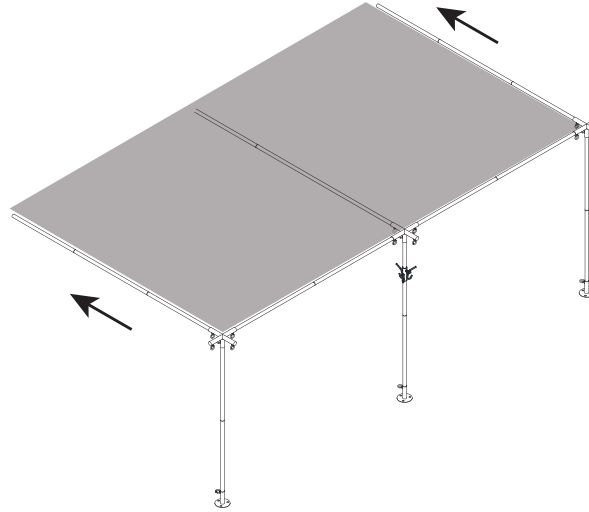

FEATURES

- Complete structure, includes tarp and anchoring kit
- Easy to install
- Superior quality and durability
- UV-resistant, heavy duty tarp
- Rust-resistant frame
- Easy to expand as your camp grows
- No guide lines
- Backed by 20+ years of testing and development
- Supports Art

Before starting: make sure you have all the parts.
A cordless driver is recommended.

IF THERE IS WIND, DO NOT ATTEMPT
TO ASSEMBLE SHADE STRUCTURE.
Have a beer and wait for wind to die down.
Shade assembly is more fun with friends.

Parts List SAK12X20

12'x20' Add Kit Box One

CODE	NAME	SIZE	QUANTITY	DRAWING
11	12FT RAFTER POLE 3PCS (WH)	50.66"	6	
12	12FT RAFTER POLE 3PCS (WH)	50.66"	3	
K	POLE BUNGEEES	Long	2	

12'x20' Add Kit Box Two















CODE	NAME	SIZE	QUANTITY	DRAWING
1	10FT RAFTER POLE 2PCS (RED)	62"	2	
2	10FT RAFTER POLE 2PCS (RED)	62"	2	
8-1	8FT LEG 2PC(BLK)	50"	3	
8-2	8FT LEG 2PC(BLK)	50"	3	
K	POLE BUNGEEES	Long	2	

12'x20' Add Kit Box Three

CODE	NAME	SIZE	QUANTITY	DRAWING
A	FOOT BASE PLATE		3	
B	5 WAY FITTINGS		3	
C	LAG BOLT	1/2X18"	3	
F	SUNBLOCK TARP	12'X20'	1	
G	BUNGEEES		50	
H	COAT RACK		1	
I	TOOLS		1	
J	STORAGE TOTE		1	
K	POLE BUNGEEES	Long	2	















Parts List: 24'x20'

12'x20' Base Kit, 12'x20' Add Kit
Together these make the 24'x20' Kit

CODE	NAME	SIZE	SBK 12'X20'	SAK 12'X20'	DRAWING
1	10FT RAFTER POLE 2PCS (RED)	62"	4	2	
2	10FT RAFTER POLE 2PCS (RED)	62"	4	2	
11	12FT RAFTER POLE 3PCS (WH)	50.66"	6	6	
12	12FT RAFTER POLE 3PCS (WH)	50.66"	3	3	
8-1	8FT LEG 2PC(BLK)	50"	6	3	
8-2	8FT LEG 2PC(BLK)	50"	6	3	
A	FOOT BASE PLATE		6	3	
B	5-WAY FITTINGS		6	3	
C	LAG BOLT	1/2X18"	6	3	
F	SUNBLOCK TARP	12' X 20'	1	1	
G	BUNGEEES	7'	50	50	
H	COAT RACK		1	1	
I	TOOLS		1		
J	STORAGE TOTE		1	1	
K	BUNGEEES	Long	6	6	

Parts List: 36'x20'

12'x20' Base Kit, 2 pc 12'x20' Add Kits
Together these make the 36'x20' Kit

CODE	NAME	SIZE	SBK 12'X20'	SAK 12'X20'	DRAWING
1	10FT RAFTER POLE 2PCS (RED)	62"	4	4	
2	10FT RAFTER POLE 2PCS (RED)	62"	4	4	
11	12FT RAFTER POLE 3PCS (WH)	50.66"	6	12	
12	12FT RAFTER POLE 3PCS (WH)	50.66"	3	6	
8-1	8FT LEG 2PC(BLK)	50"	6	6	
8-2	8FT LEG 2PC(BLK)	50"	6	6	
A	FOOT BASE PLATE		6	6	
B	5-WAY FITTINGS		6	6	
C	LAG BOLT	1/2X18"	6	6	
F	SUNBLOCK TARP	12' X 20'	1	2	
G	BUNGEEES	7'	50	100	
H	COAT RACK		1	2	
I	TOOLS		1		
J	STORAGE TOTE		1	2	
K	BUNGEEES	Long	6	12	

Assembly Instructions

1. Assemble upper frame: Connect the 2pc 10ft rafter poles, then the 3pc 12ft rafter poles. Connect to the 5-way fittings making sure all the button locks engage on the poles and the eye bolts are firmly tight (do not over tighten with a tool and crush the pole). Make sure all poles are fully engaging 5-way Fitting and the frame is square. see Fig A

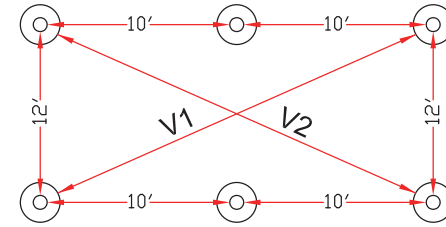
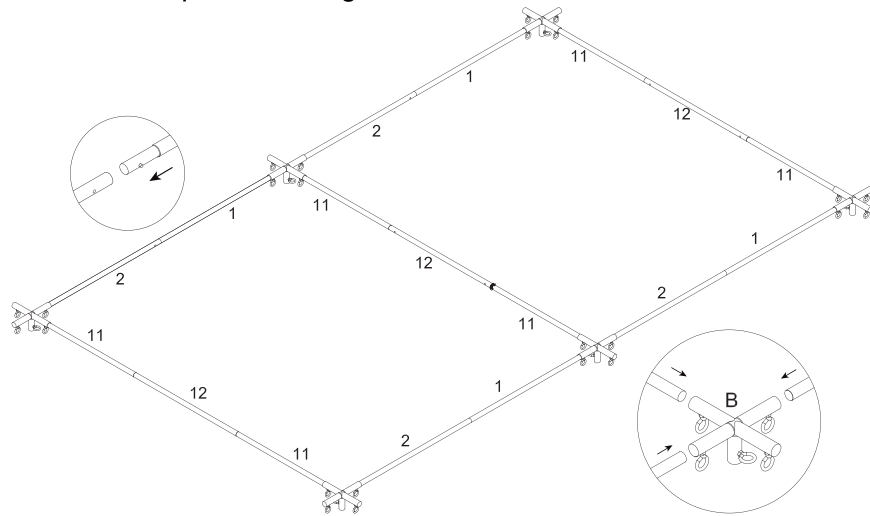

V1=V2

Fig A

2. Attach the tarp: Lay the tarp over the top of the frame. Secure with bungees starting with 2 bungees in each corner. Once all the corners are done, continue securing the entire tarp.

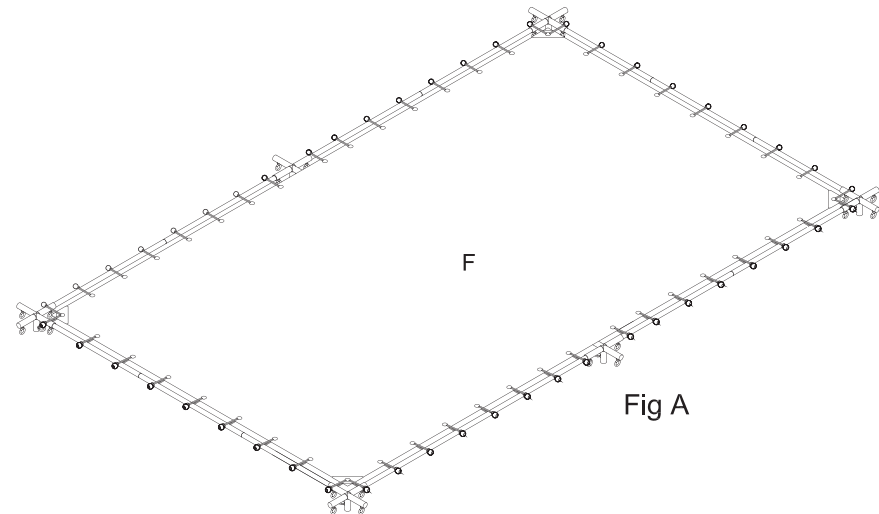
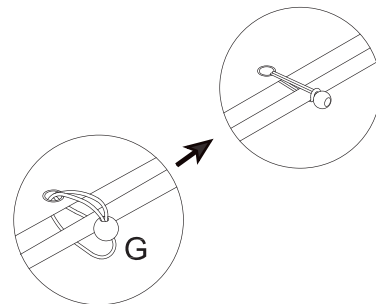
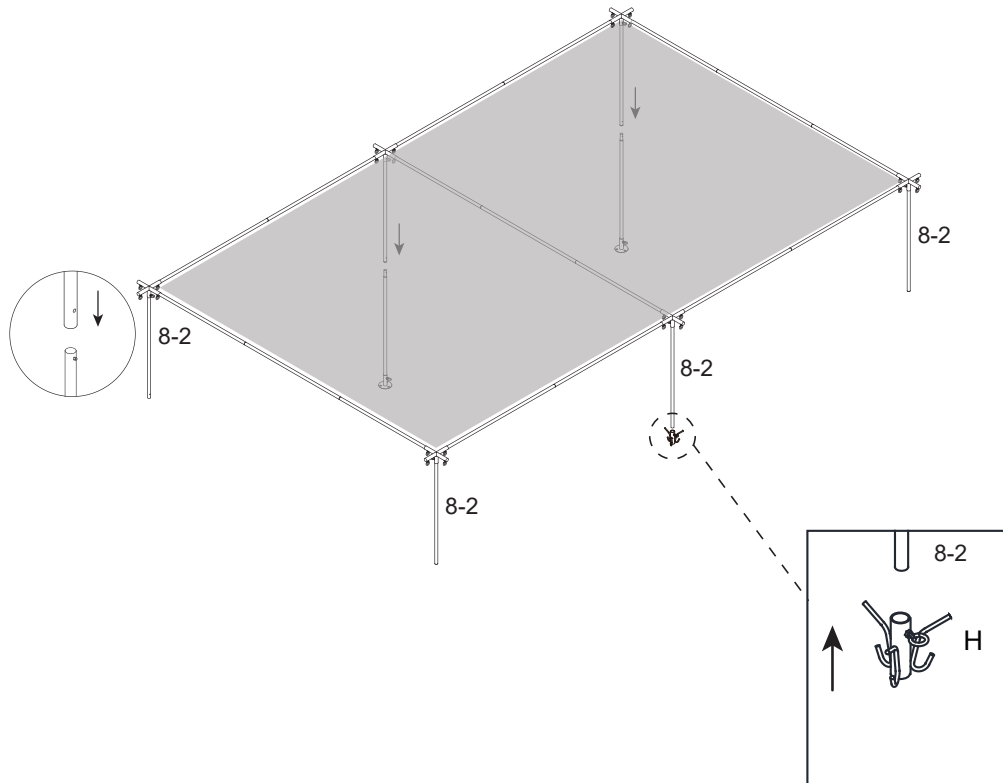

Fig A

3. Install upper leg pole:

Lift the frame up one side at a time and install the upper half of the leg #8-2, repeat for each side making sure the buttons are securely clicked into place and the eye bolts are tightened firmly (do not over tighten with a tool and crush the pole). This a good time to select the leg you want the coat rack on and slip it into place. You can adjust the height later. This also applies to the optional table if purchased.



4. Install upper leg pole:

Place the foot base on the bottom of the lower leg half 8-1 making sure the buttons are securely clicked into place and the eye bolts are firmly tight (do not over tighten with a tool and crush the pole).



5. Raise the roof! Lift the frame up one side at a time and install the lower half of the leg #8-1 into #8-2, repeat for each side making sure the buttons are securely clicked into place

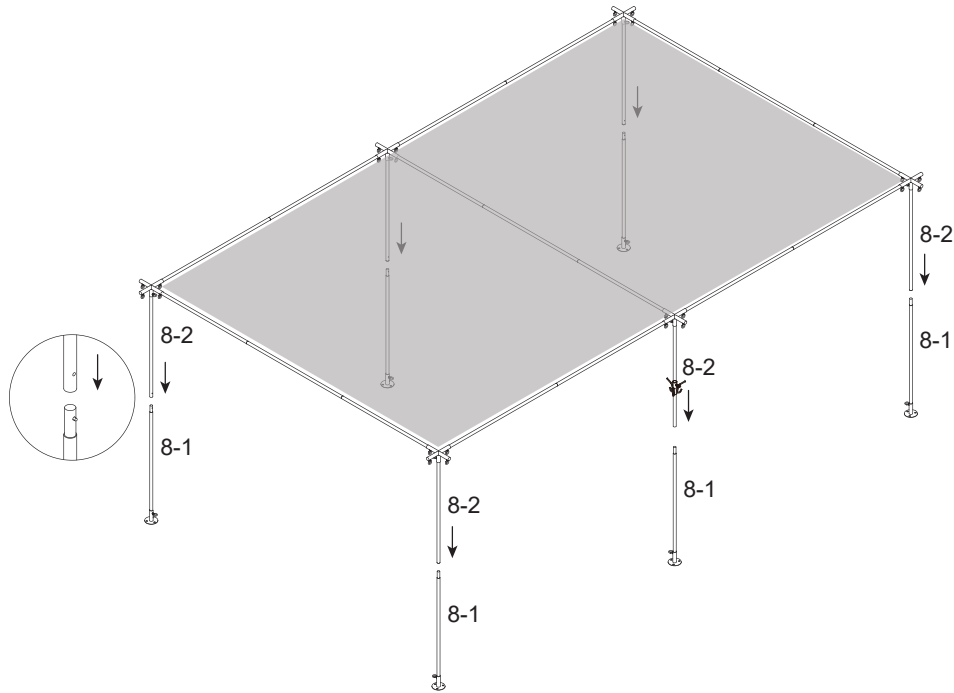

6. Locate and secure

With a person on each leg you can now walk your structure to the desired final placement. Make sure the structure is placed square and the legs are straight, then select one of the 3 holes in each foot drive the 18" lag fully into the ground.

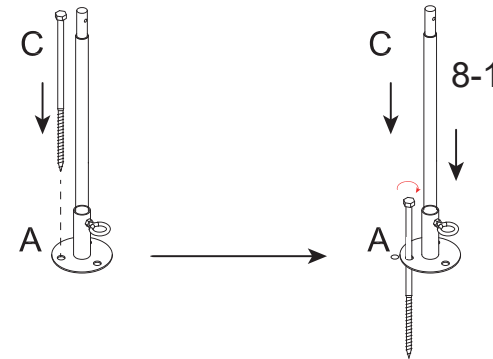
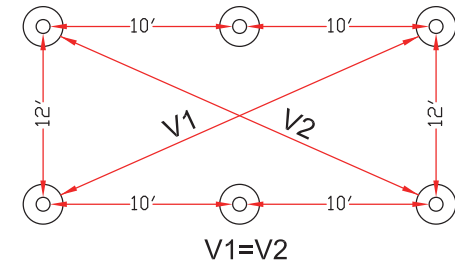

7. Enjoy Now admire your work while you enjoy a low quality beer under your high quality shade.

For added peace of mind & security under exposed or extreme conditions we recommend securing the major corners of the structure with tie downs

24'X20' & 36'x20' Shade Structure ☒

8. 24'X20' & 36'x20' Shade Structures

The 24'x20' can be built the same as a 12x20 instructions above and additional 12x20 structures can be added to the base by extending the frame only 1st, then attaching the tarp after the full frame is attached to the existing structure and secured to the ground. Do not attempt building larger structures or additions in the wind. You will need a ladder.

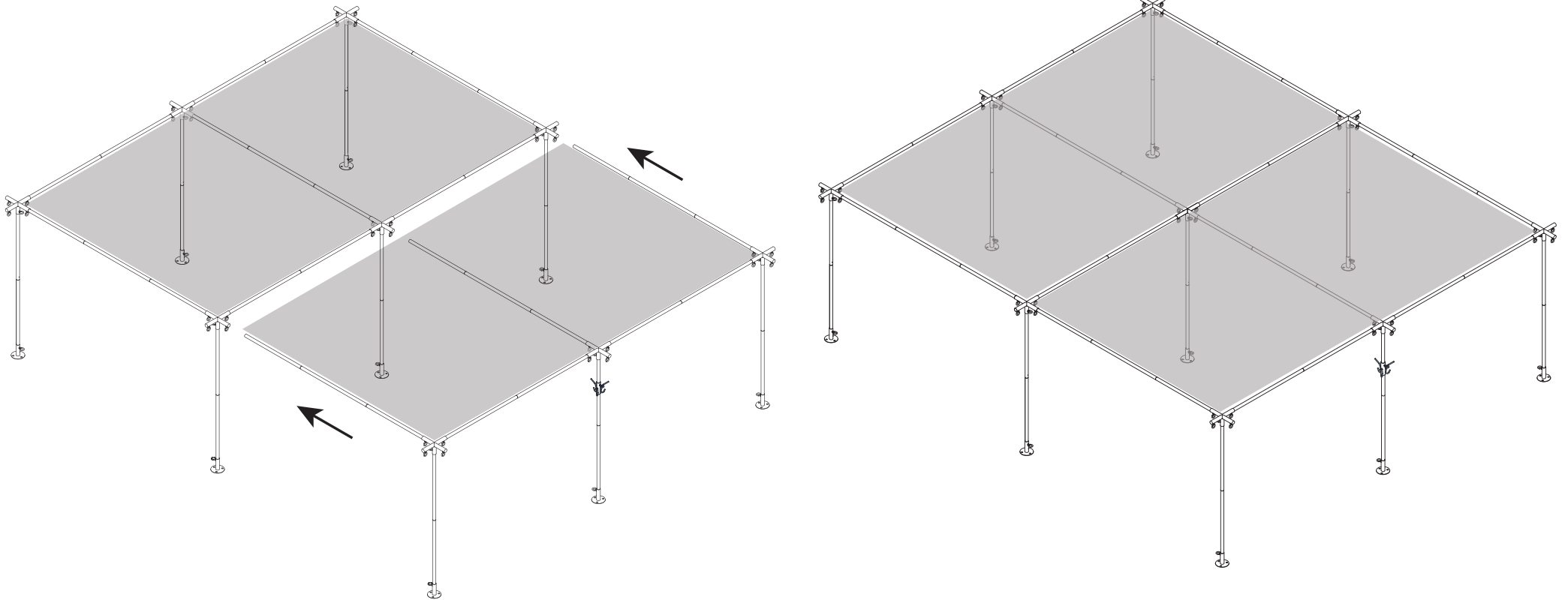

Now admire your work while you enjoy a low quality beer under your high quality shade.

Blackrock Hardware Oakland CA
www.blackrockhardware.com

IF THERE IS WIND, DO NOT ATTEMPT TO ASSEMBLE SHADE STRUCTURE.
Have a beer and wait for wind to die down.
Shade assembly is more fun with friends.